

INSTRUCTION

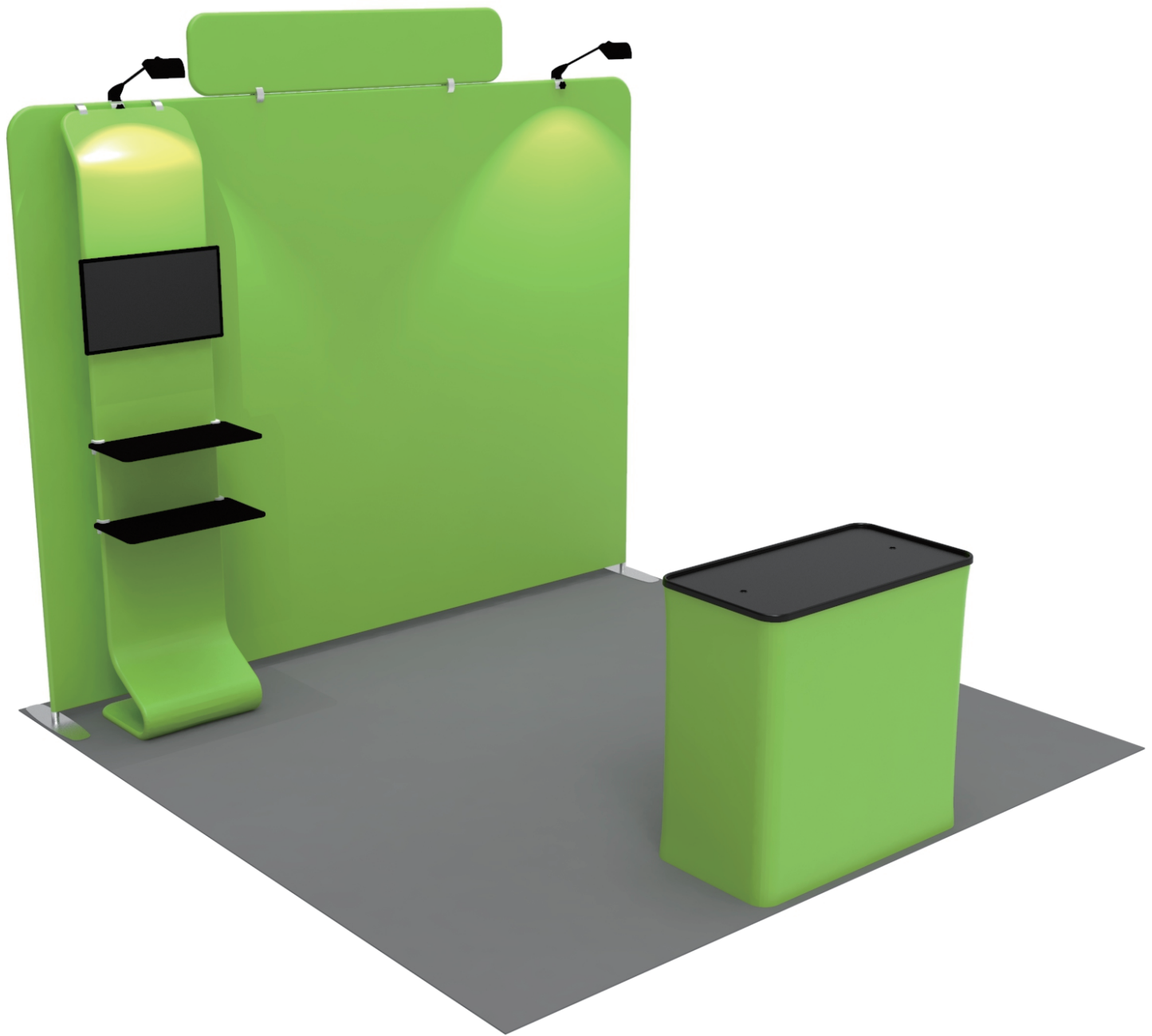

TF-SB-10X10-17

STEPS

(1) Hardware

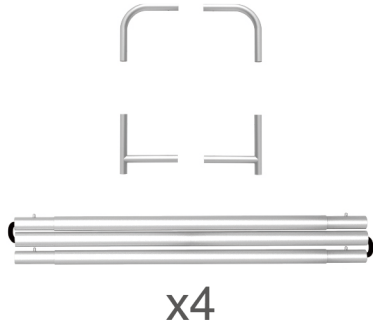

(2) Printed Graphic Fabric Banner (Optional)



STEP 01

Connect to make long poles according to labelings.

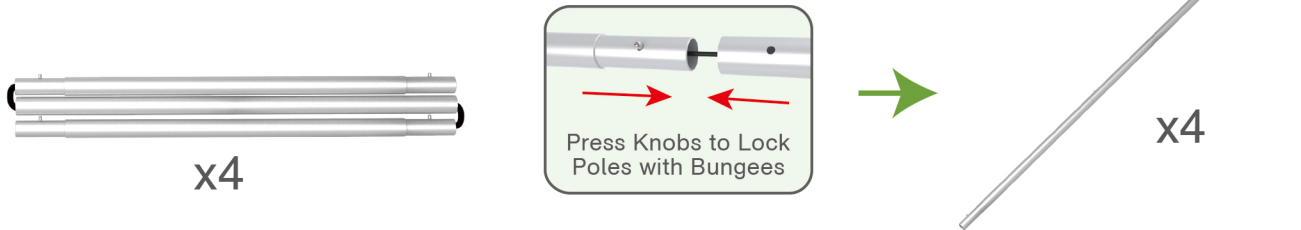

STEP 02

Connect long poles with corner poles according to labelings.

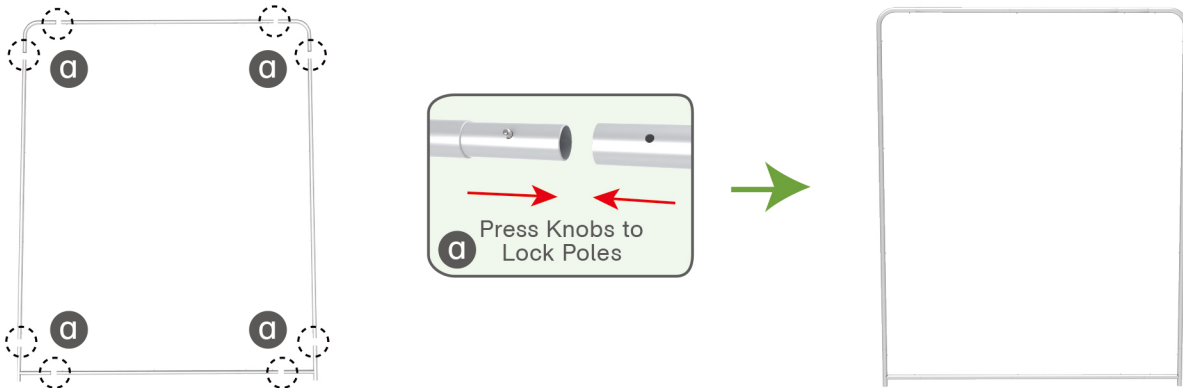

STEP 03

Slide fabric banner on frame from top and zip up at bottom.

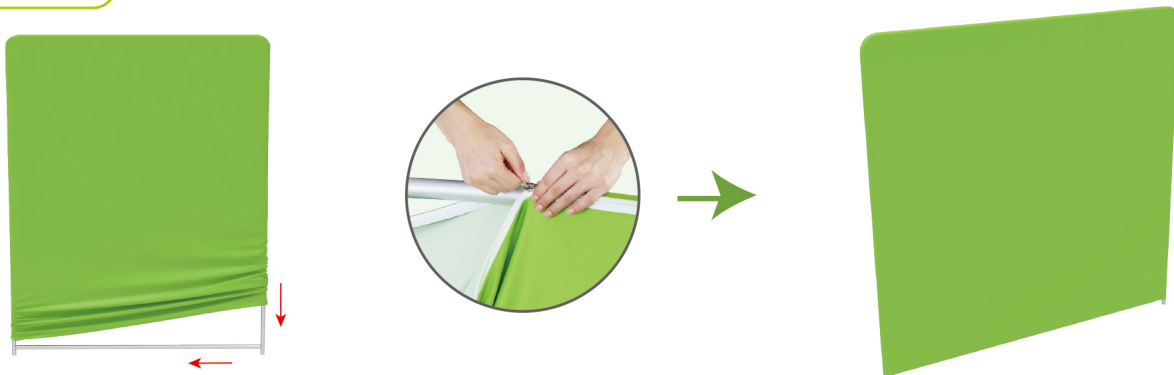

STEPS

(1) Hardware

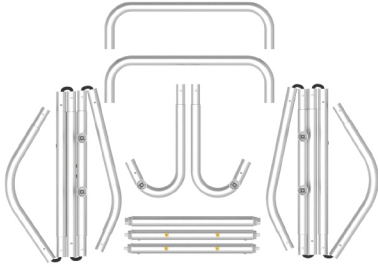

(2) Printed Graphic Fabric Banner (Optional)



STEP 01

Connect to make long poles according to labelings.

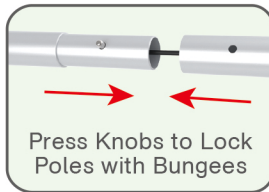

STEP 02

Connect long poles with corner poles according to labelings.

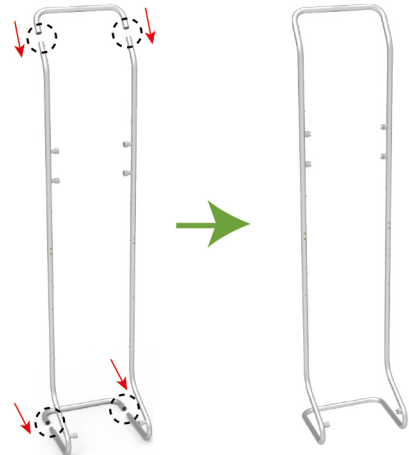
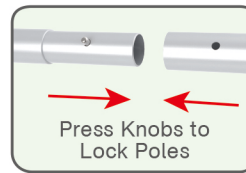
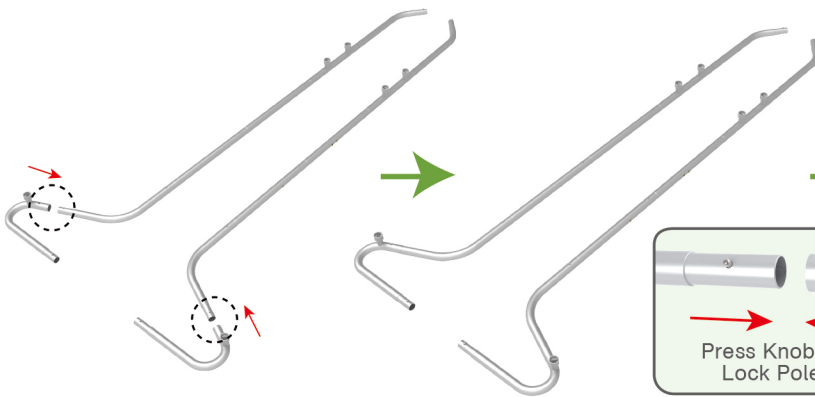

STEP 03

Install cross bars in position.

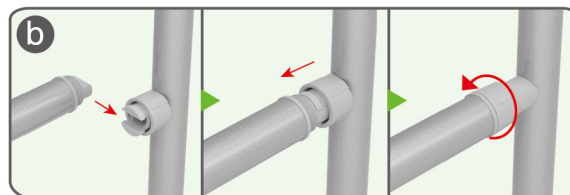

★ One Tool (Hex Wrench) 

STEPS

STEP 04 Slide fabric banner on frame from top and zip up at bottom.

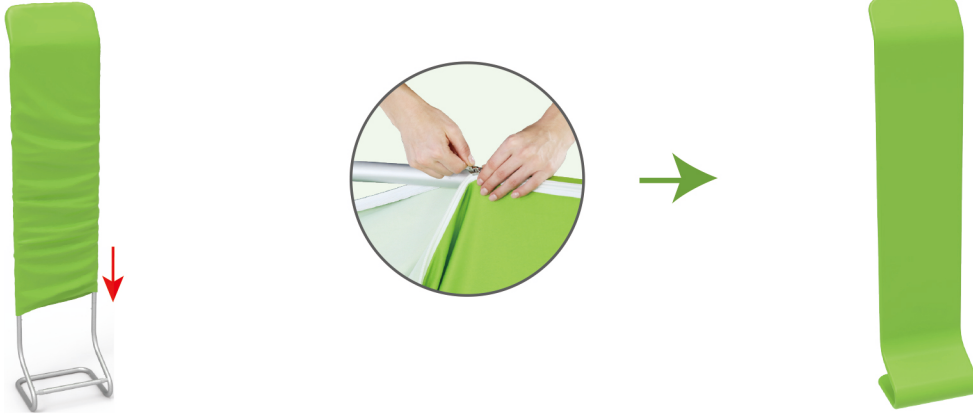

(1) Hardware



(2) Printed Graphic Fabric Banner



STEP 01 Connect poles according to labelings.

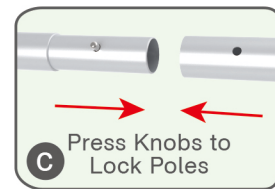
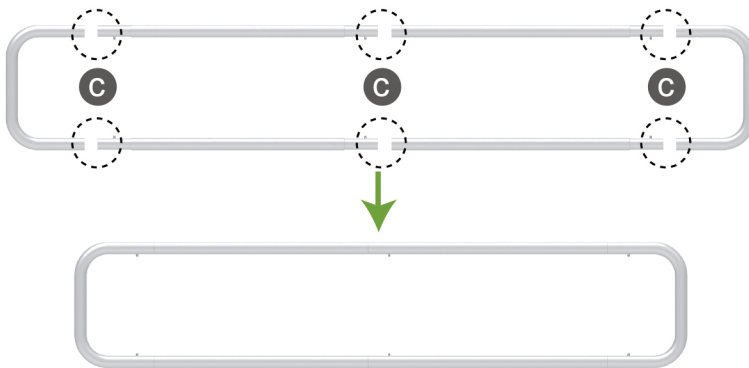

STEP 02 Slide fabric banner on frame from left and zip up at right.

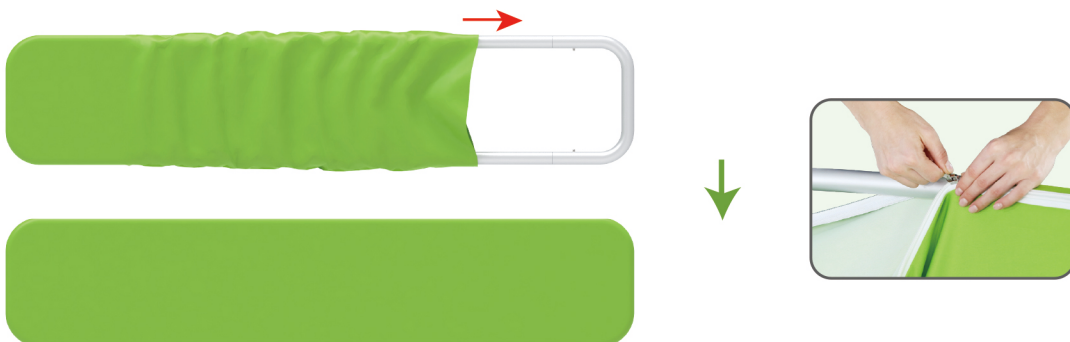

STEPS

Booth Set Assembly

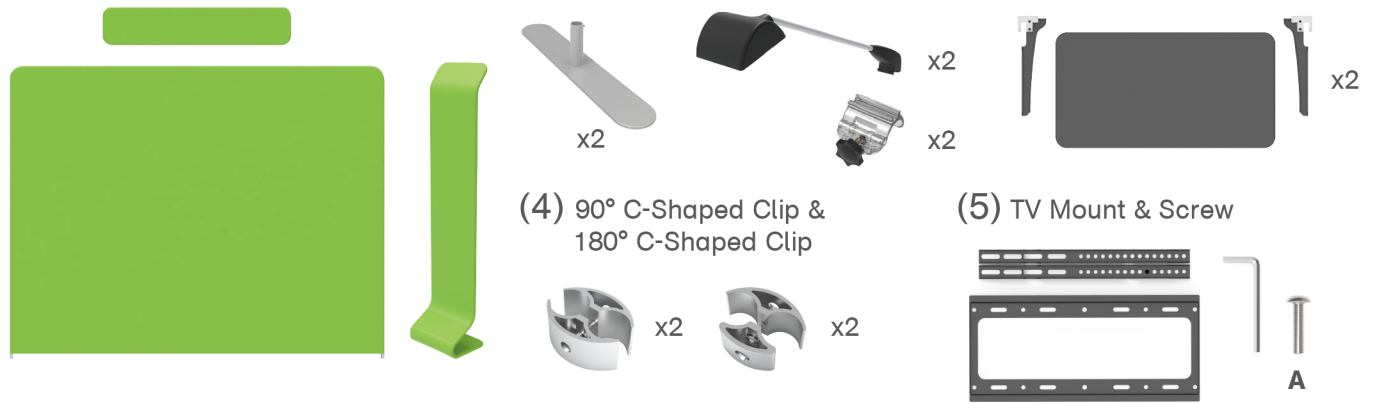

STEP 01 Interconnect display stands with C-shaped clips.

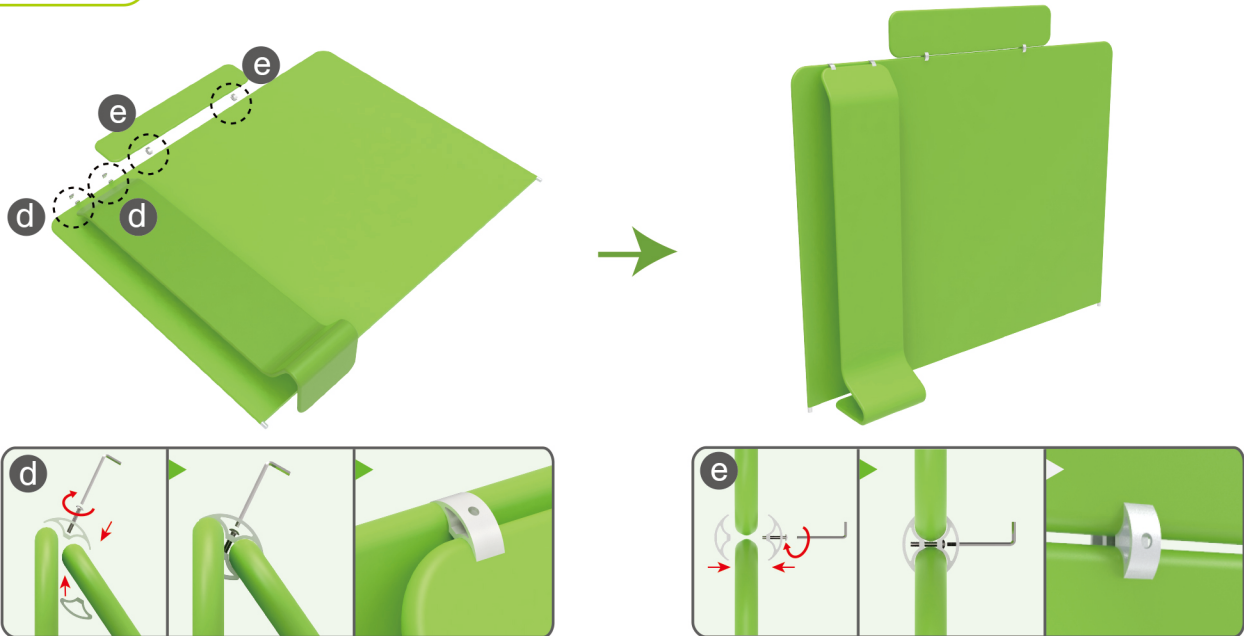

STEP 02 Insert display stands onto feet by pressing their knobs.

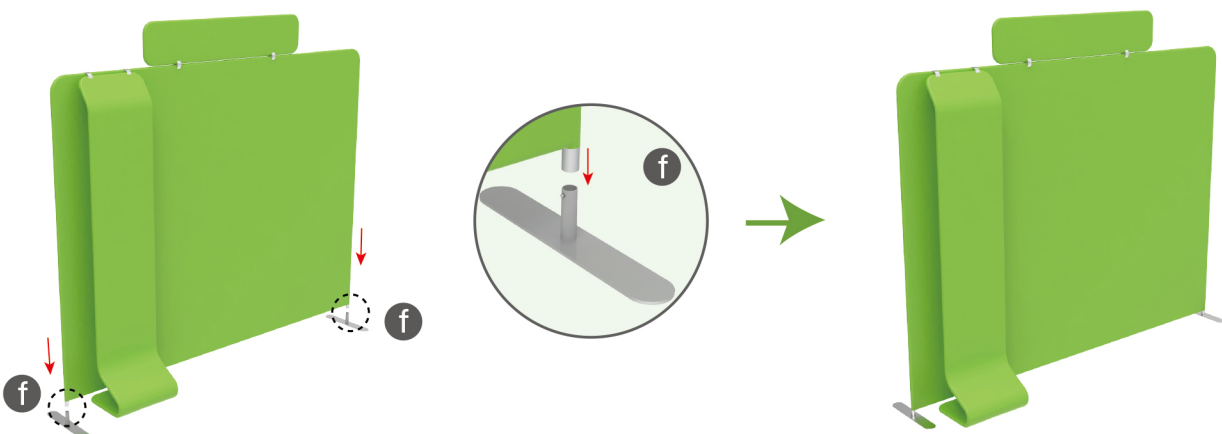

STEPS

STEP 03

Screw TV mount onto display stand & support brackets onto TV's back with hex wrench, hang TV onto mount & screw.

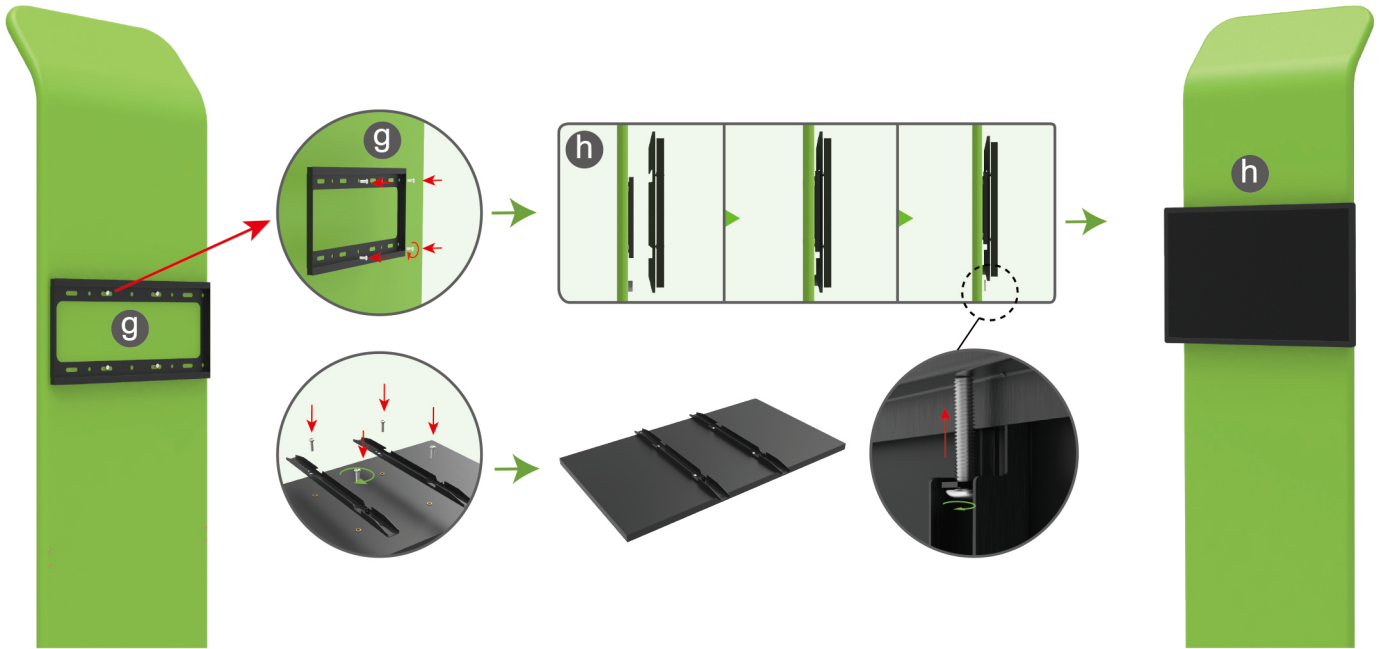

STEP 04

Screw brackets onto display stand with hex wrench, insert shelves into slots.

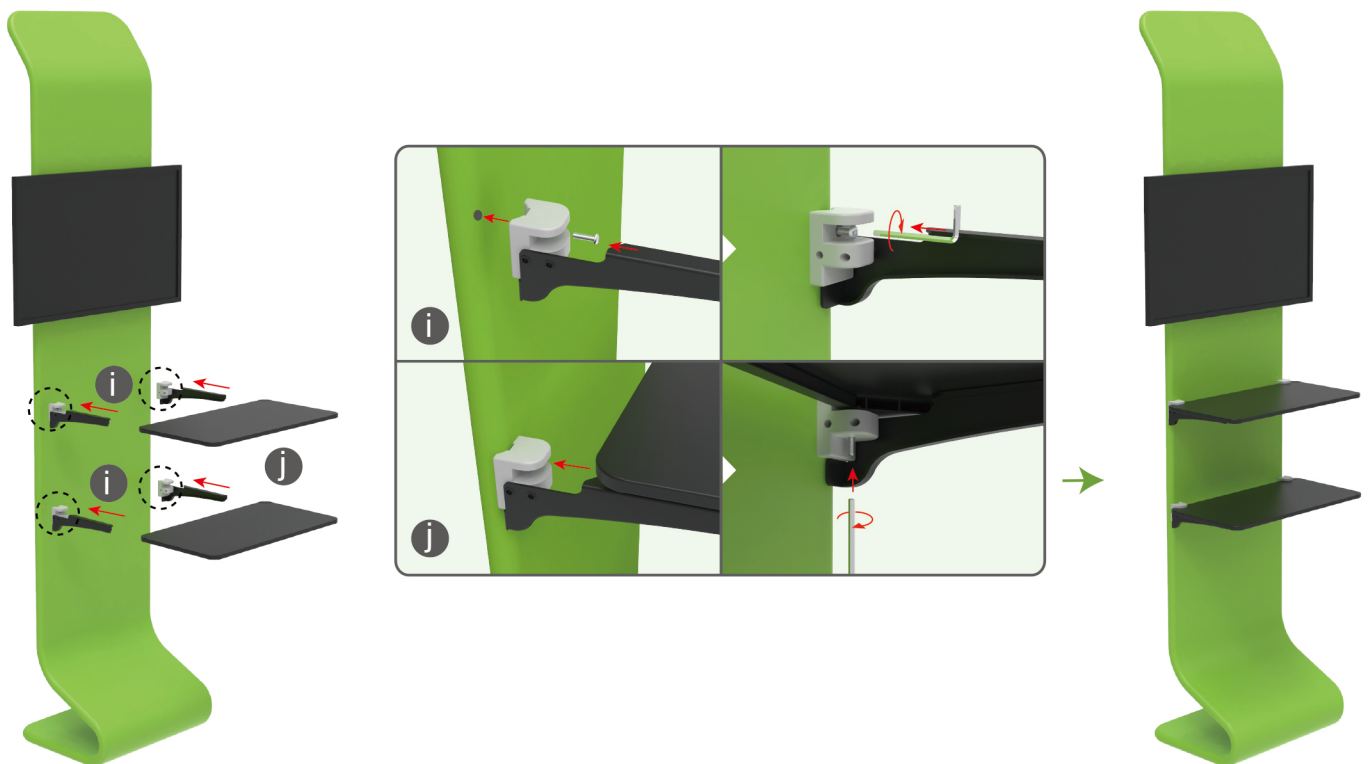

STEPS

STEP 05 Screw light clips at top of display stands, slide lights onto them and adjust their direction.

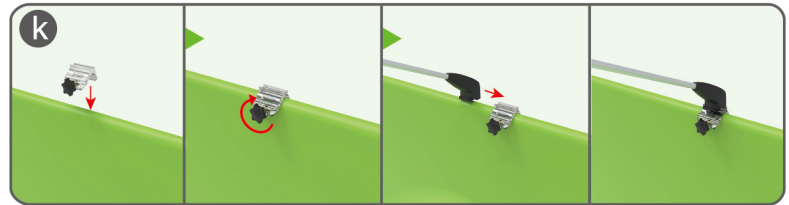
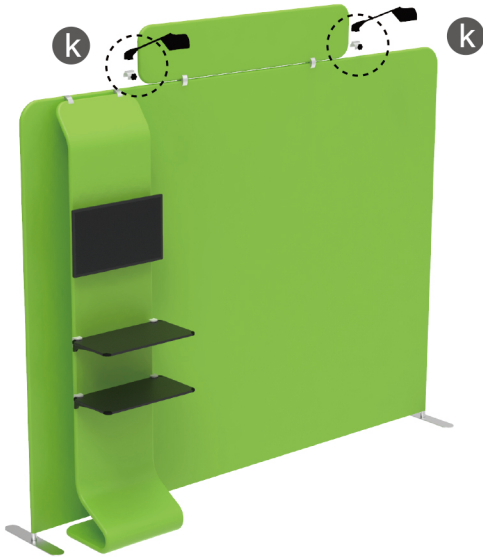

TF-SB-10X10-17

STEPS

(1) Durable Plastic Hard Case, Aluminum Support Poles



(2) Printed Graphic Fabric Banner



STEP 01

Put hard case's top into fabric banner.

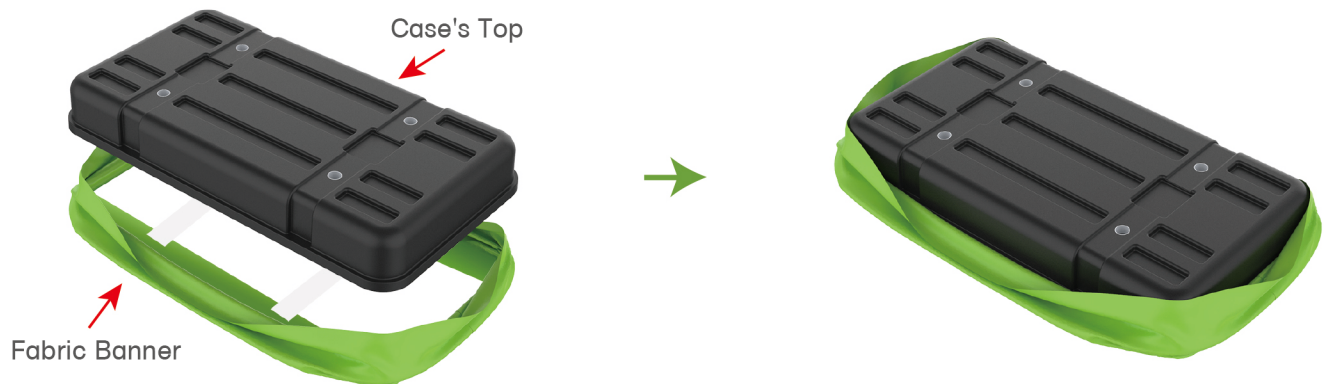

STEP 02

Insert support poles into hard case's top & bottom.

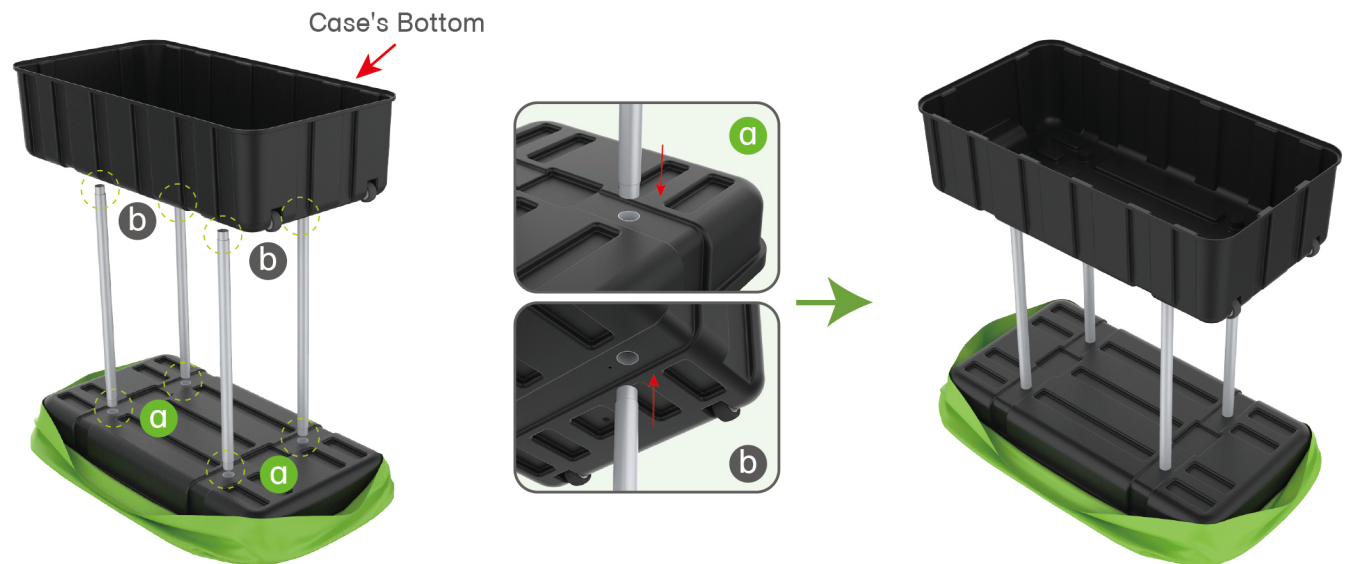

STEPS

STEP 04

Wrap fabric banner from bottom to top & twist it to be smooth, lay hard case's intermediate panel on podium's top.

