

INSTRUCTION



10X10FT-BOOTH-16

STEPS

(1) Hardware

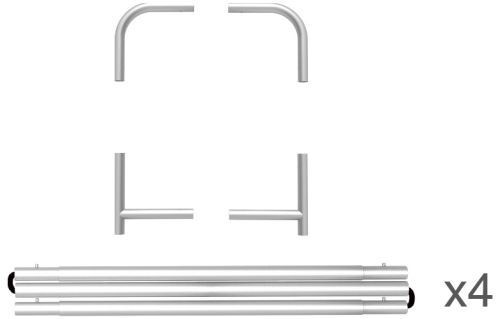

(2) Printed Graphic Fabric Banner (Optional)



STEP 01 Connect to make long poles according to labelings.

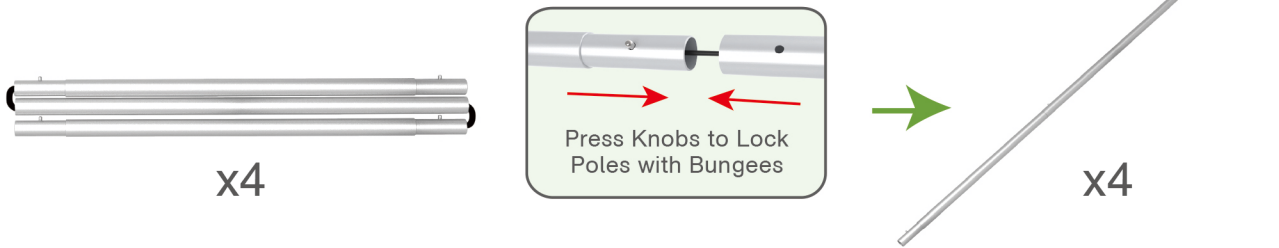

STEP 02 Connect long poles with corner poles according to labelings.

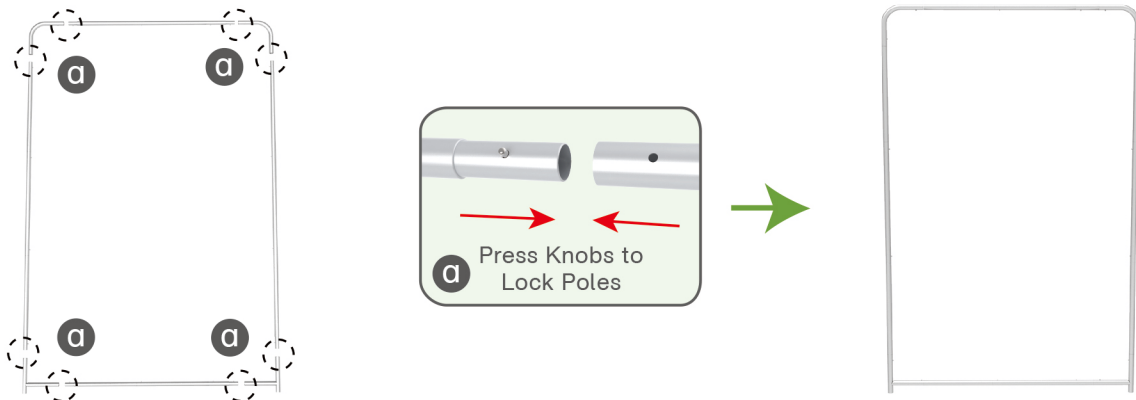

STEP 03 Slide fabric banner on frame from top and zip up at bottom.

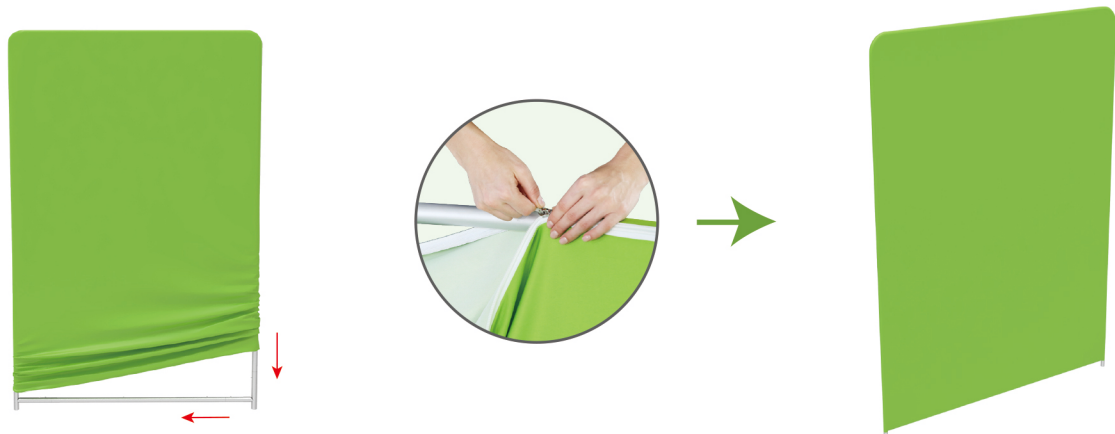

STEPS

(1) Hardware

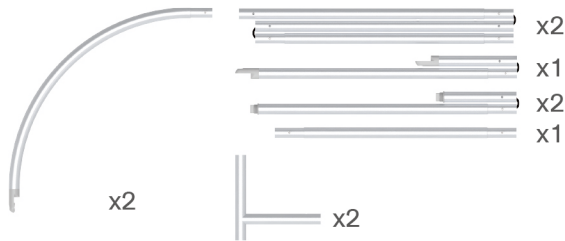

(2) Printed Graphic Fabric Banner (Optional)



STEP 01 Connect to make long poles according to labelings.

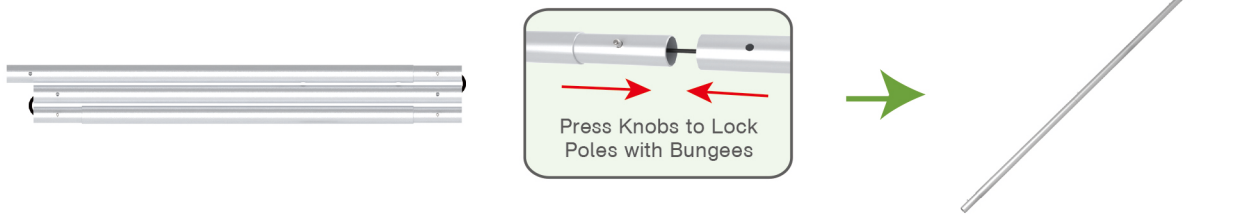

STEP 02 Connect long poles with corner poles according to labelings.

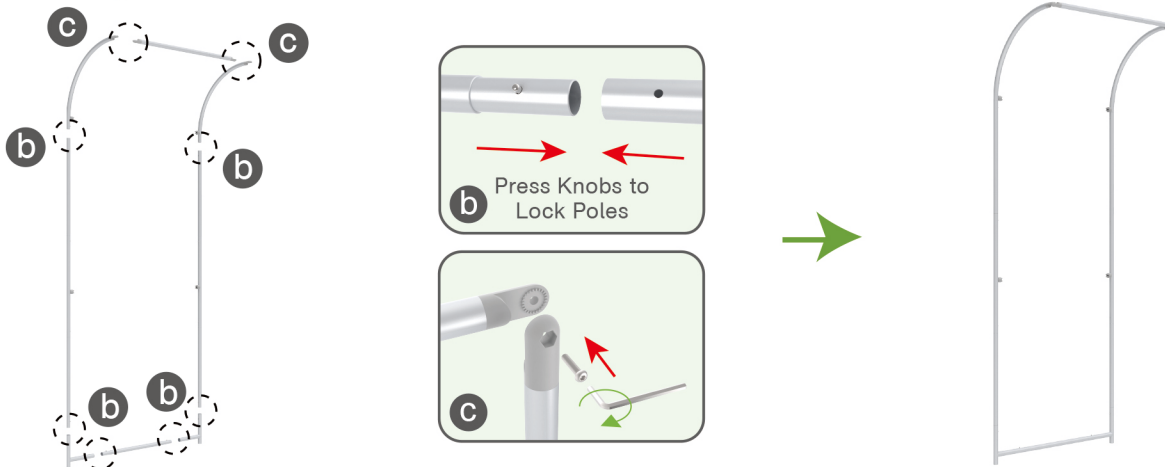

STEP 03 Install cross bars in position.

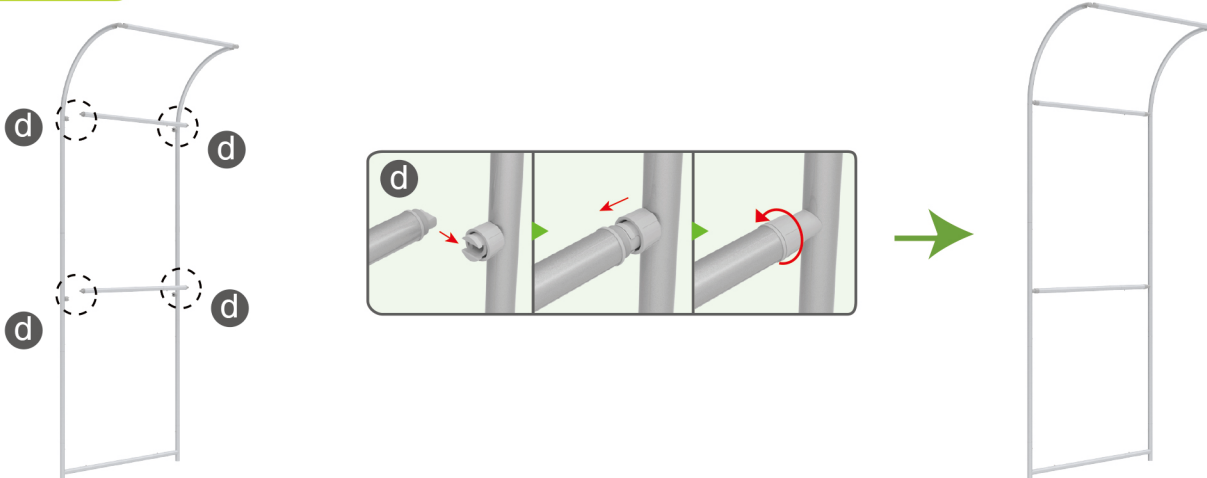

STEPS

STEP 04 Slide fabric banner on frame from top and zip up at bottom.

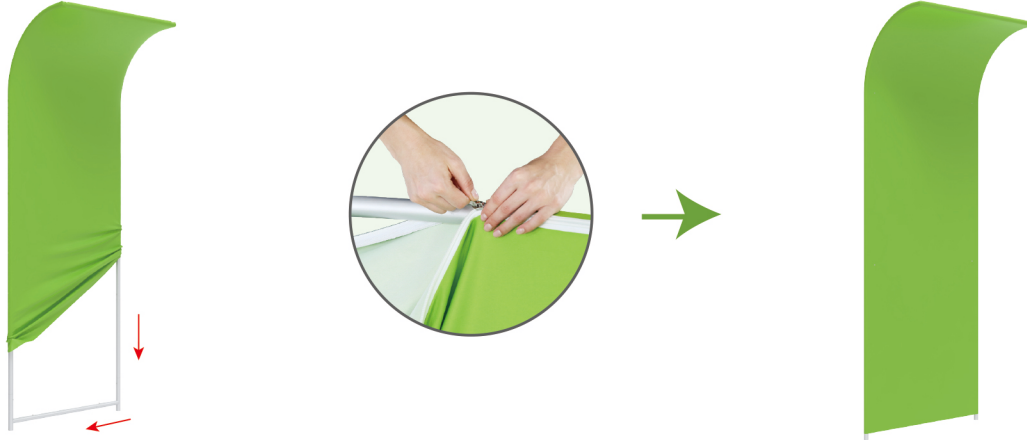

(1) Hardware



(2) Printed Graphic Fabric Banner (Optional)



STEP 01 Connect poles according to labelings.

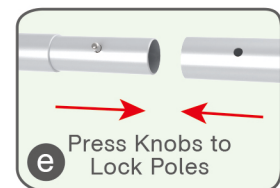
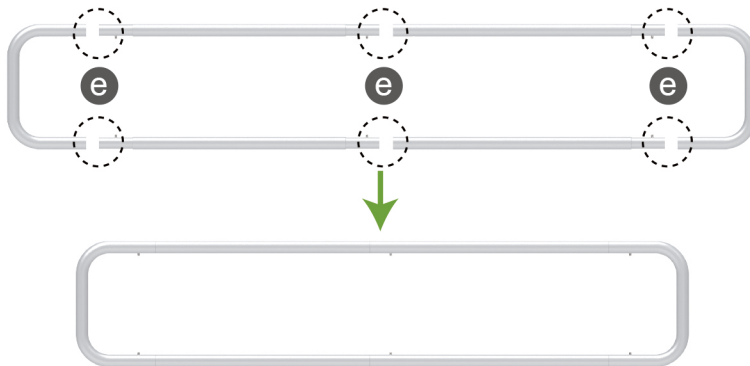

STEP 02 Slide fabric banner on frame from left and zip up at right.

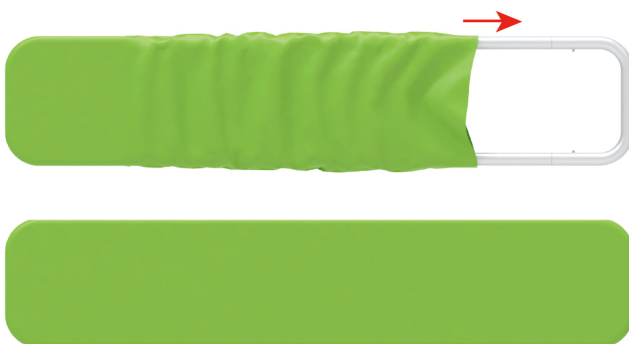

STEPS

Booth Set Assembly



(1) Base

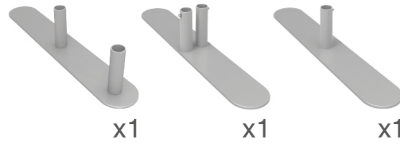

(3) MDF Board Table

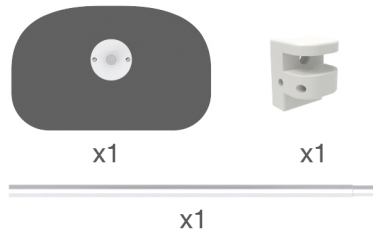

(4) C-Shaped Clip & TV Mount

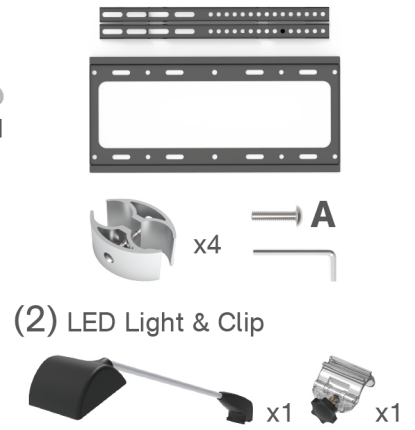

STEP 01 Interconnect display stands with C-shaped clips.

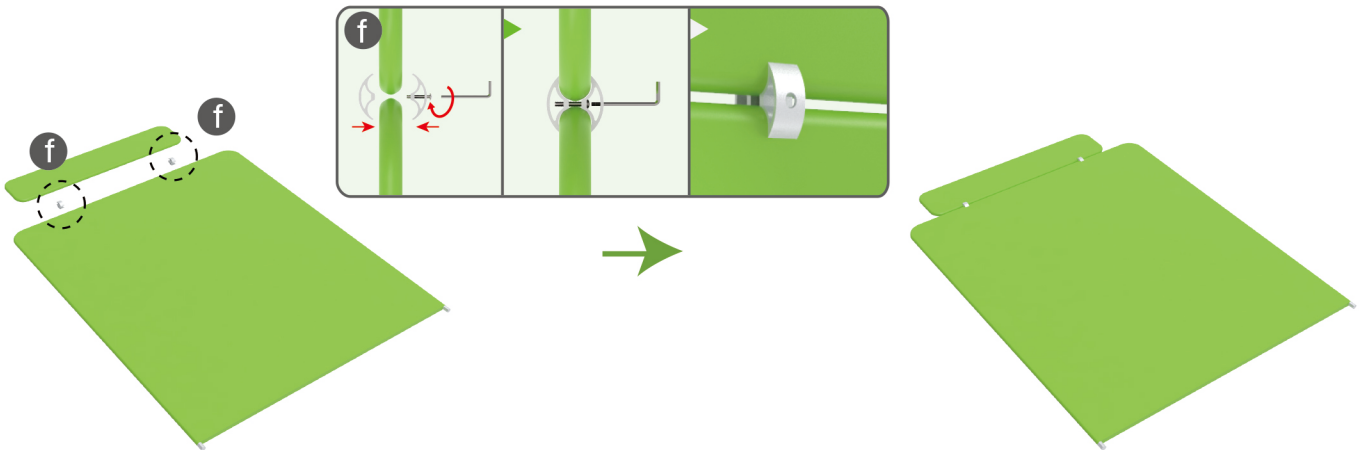

STEP 02 Insert display stands onto feet by pressing their knobs.

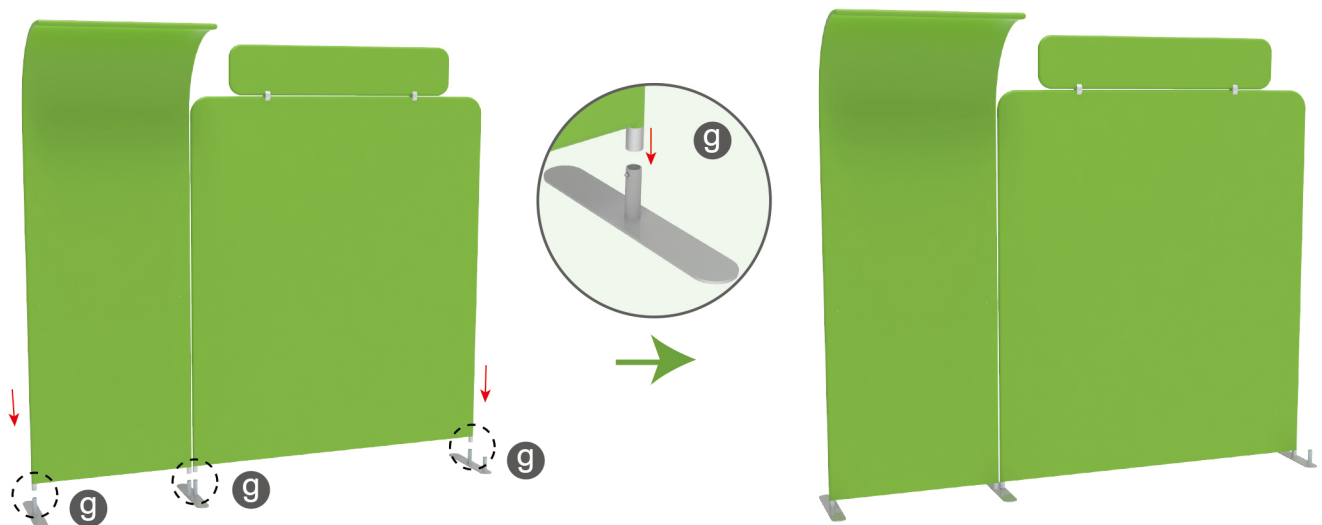

STEPS

STEP 02 Interconnect display stands with C-shaped clips.

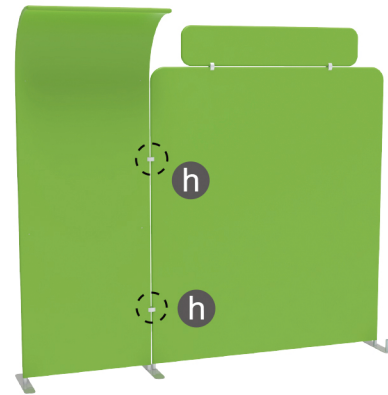
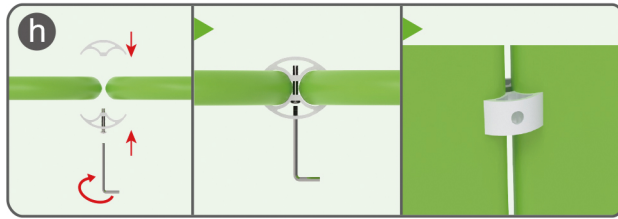

STEP 03

Insert pole into base, screw clamp with hex wrench, place MDF board onto pole & insert into clamp with screw.

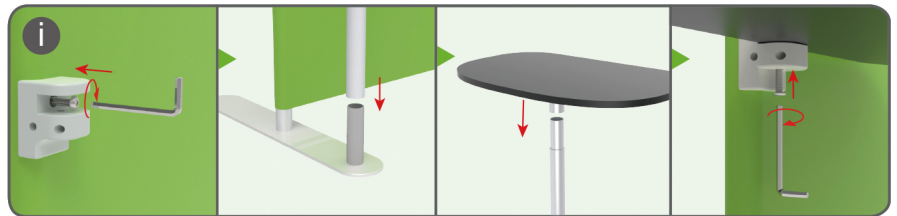
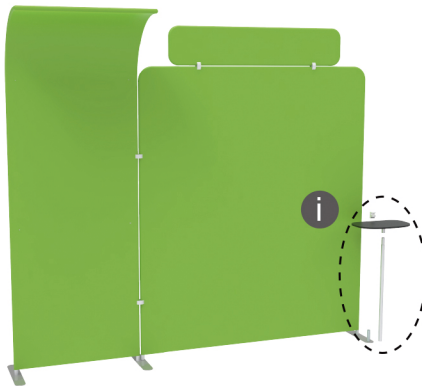

STEP 04 Screw TV mount with hex wrench.

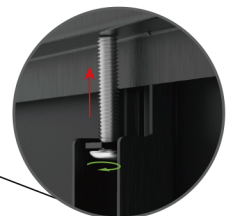
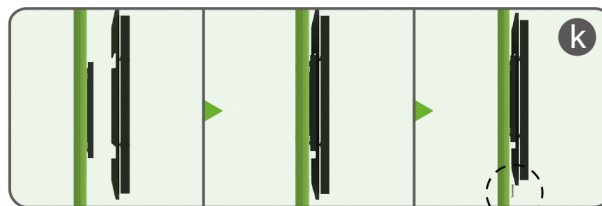
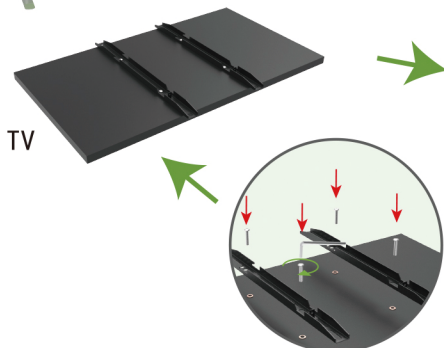
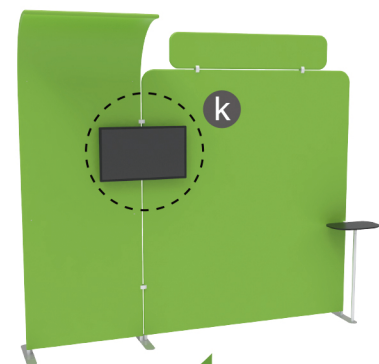
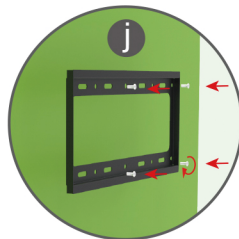
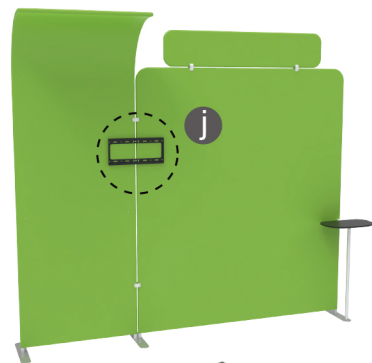

STEPS

STEP 05

Screw light clips at top of display stands, slide lights onto them and adjust their direction.

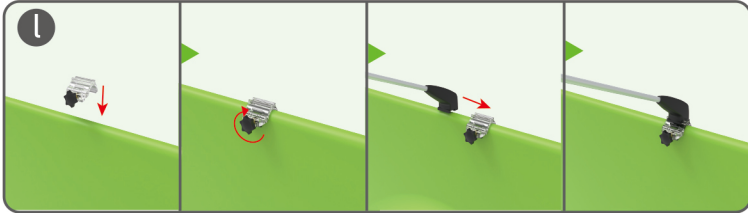

10X10FT-BOOTH-16

STEPS

(1) Durable Plastic Hard Case, Aluminum Support Poles



(2) Printed Graphic Fabric Banner



STEP 01

Put hard case's top into fabric banner.

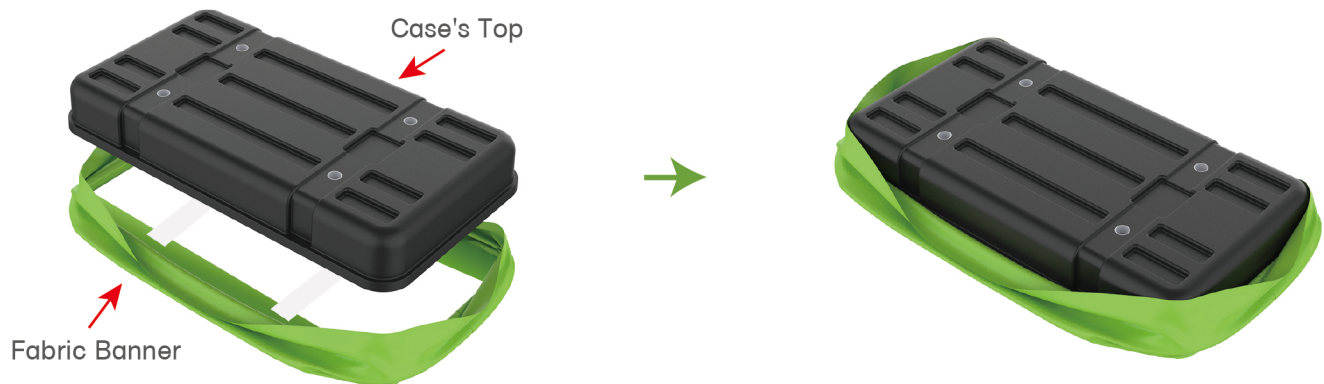

STEP 02

Insert support poles into hard case's top & bottom.

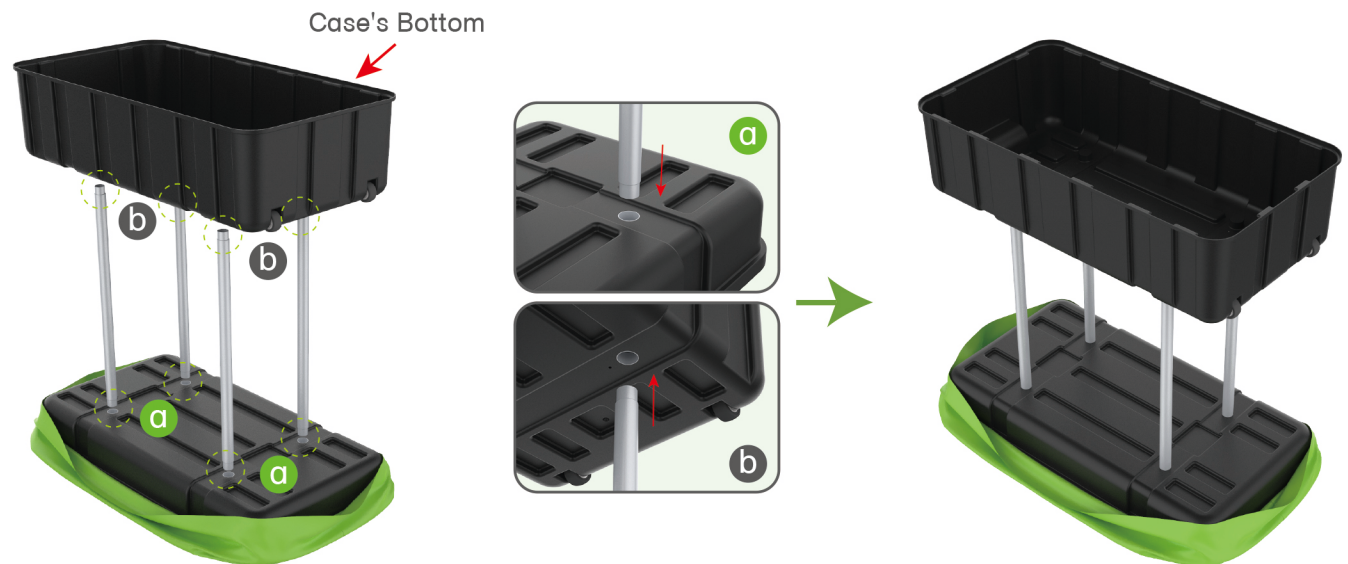

STEPS

STEP 04

Wrap fabric banner from bottom to top & twist it to be smooth, lay hard case's intermediate panel on podium's top.

